

SEAT León, 3-dr Hatchback, 12-

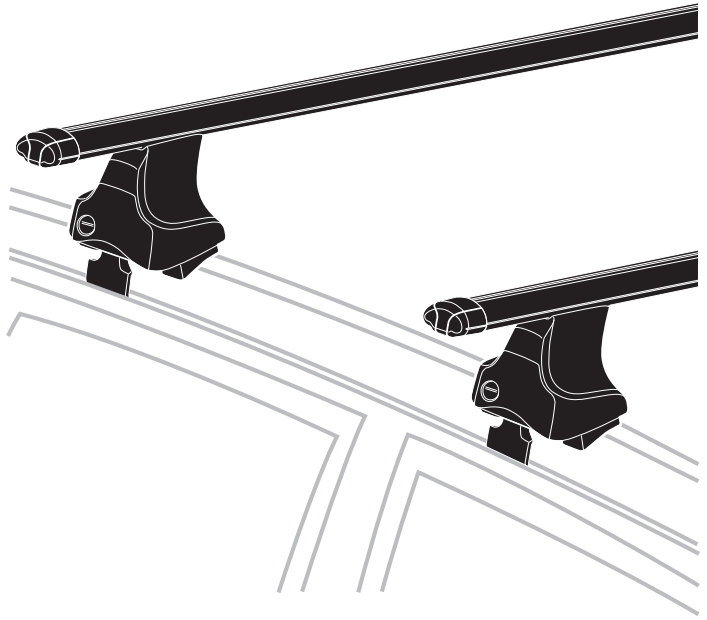

101626

ISO 11154-E

THULE[®]
SWEDEN

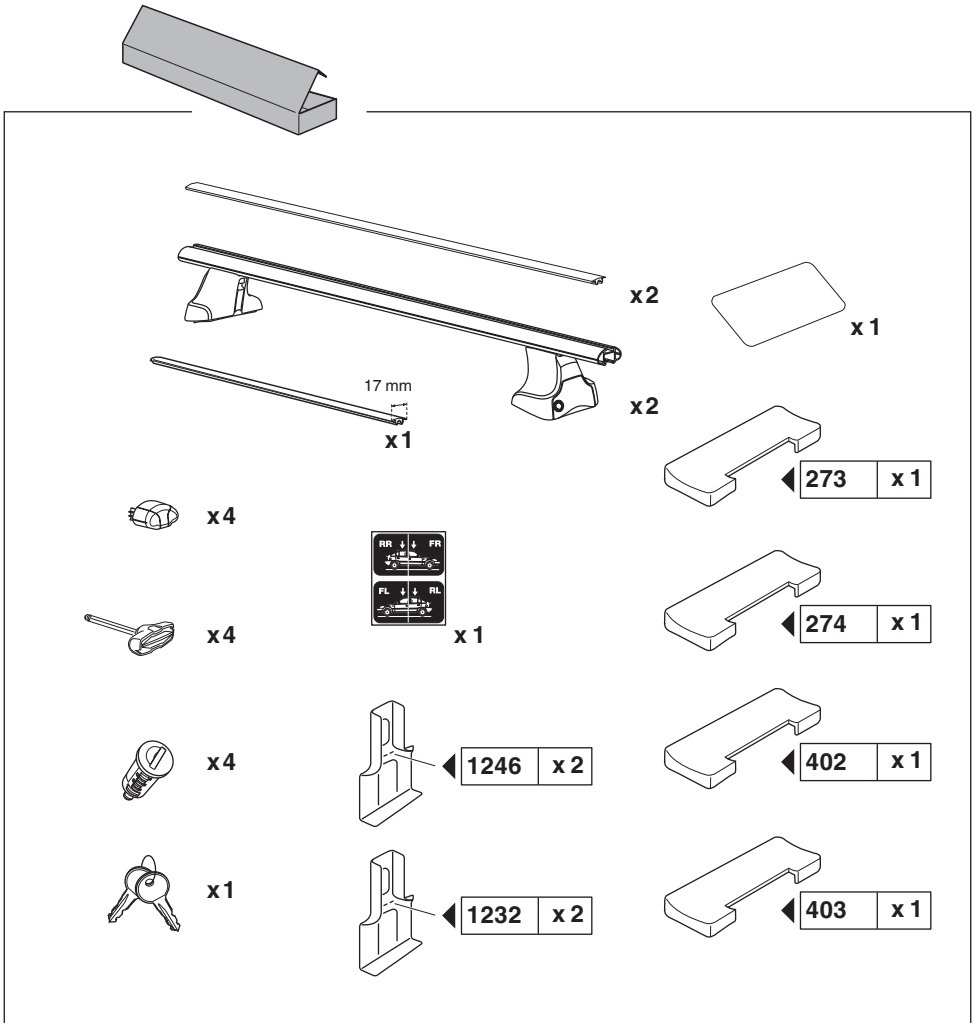
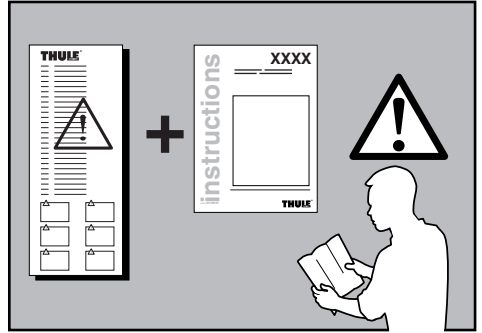
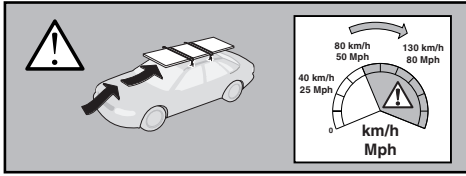
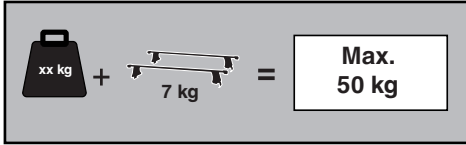

1

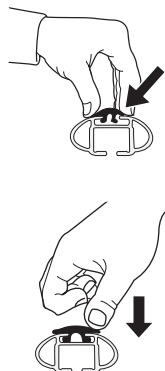
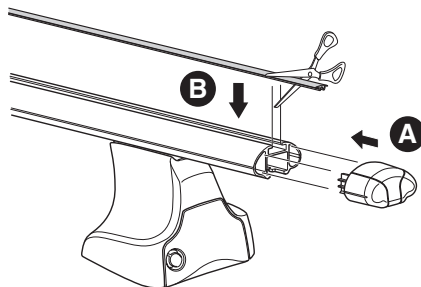
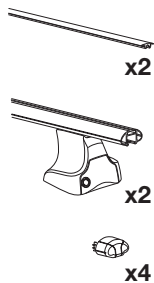

2

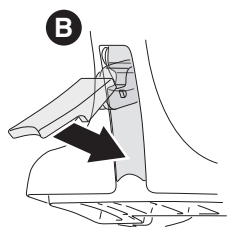
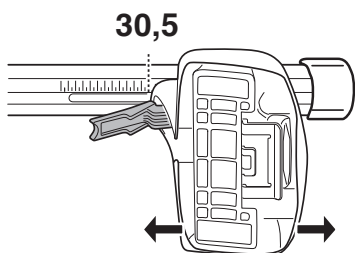
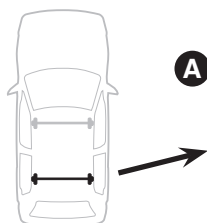
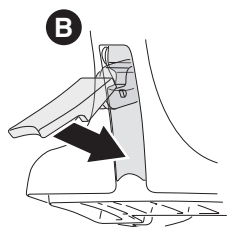
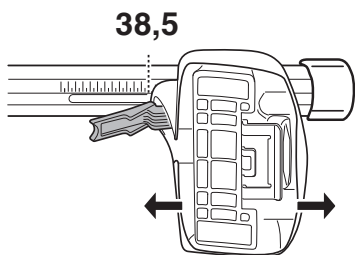
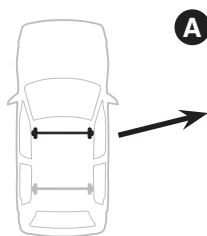
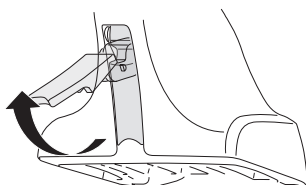

3

x4

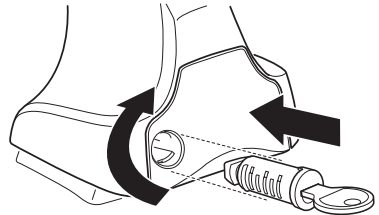
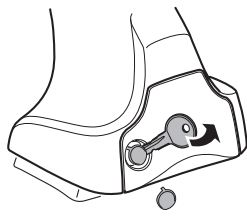
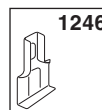
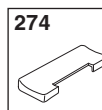
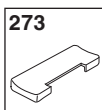
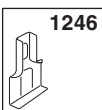
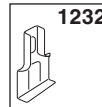
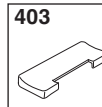
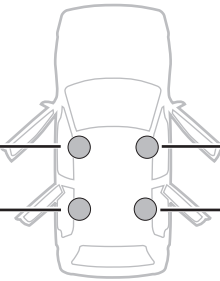
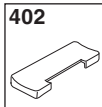
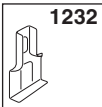
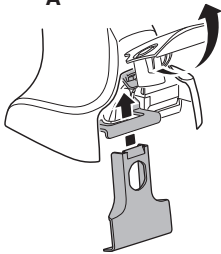
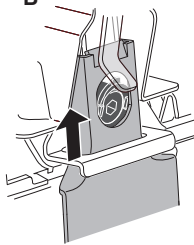
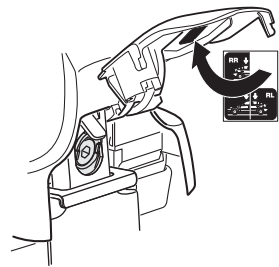
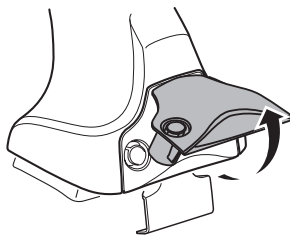
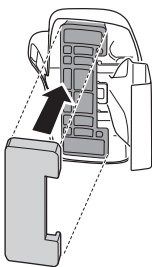
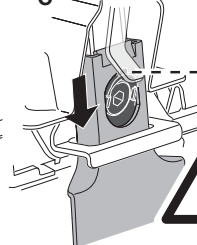

x1

**4****SEAT León, 3-dr Hatchback, 12-****A****B****C**

5

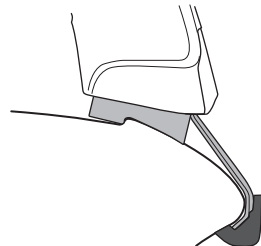
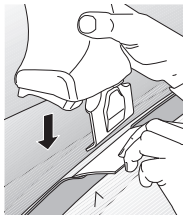
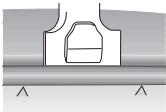
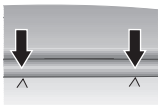
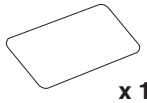
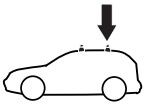
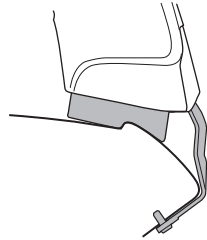
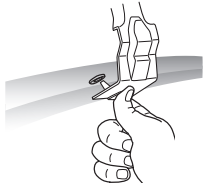
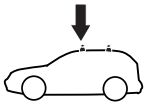
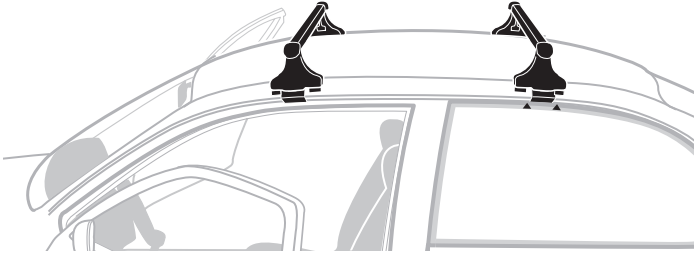
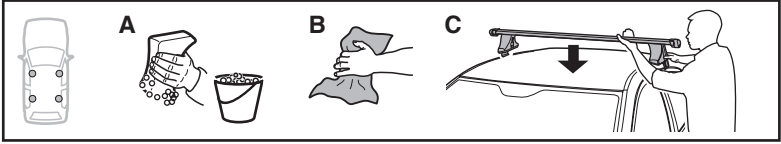

6

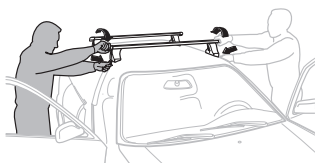

GB/US	Tighten alternately
D	Die Schrauben abwechselnd anziehen
F	Serrer alternativement chaque côté
NL	Afwisselend aan de linker- en de rechterkant aandraaien
I	Alternare il serraggio delle viti
E	Apretar alternativamente
PT	Aperte alternadamente
S	Dra åt växelvis
FIN	Kierrä vuorotellen
EST	Pinguldage vaheldumisi
LAT	Pievēlciet pamišus
LIT	Užsukinėkite pakaitomis
PL	Śruby dokręcaj naprzemiennie
RU	Затягивайте попеременно

CZ	Pokřetla bagážnika dokřečaj dokřečaj naprzemiennie.
SK	Dofahujte striedavo
SLO	Privijajte izmenično.
HR	Naizmjenično zategnite
HU	Egy mástól függetlenül szorítandó
GR	Σφιγίγετε εναλλάξ
TR	Dönüşümlü sıkın

中文 交替拧紧

한국어 번갈아 가며 조이십시오.

日本語 交互に締め付けてください。

ไทย ชั่งนแบบสลับ

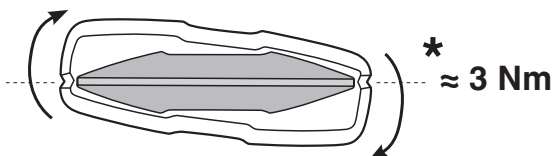
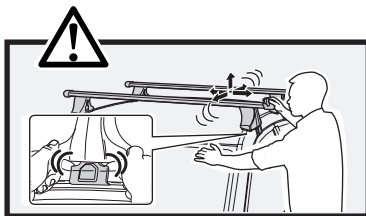
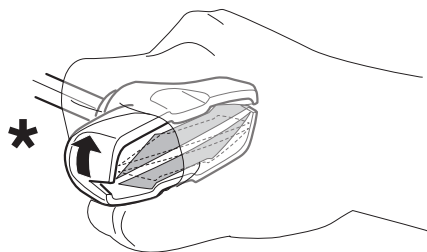
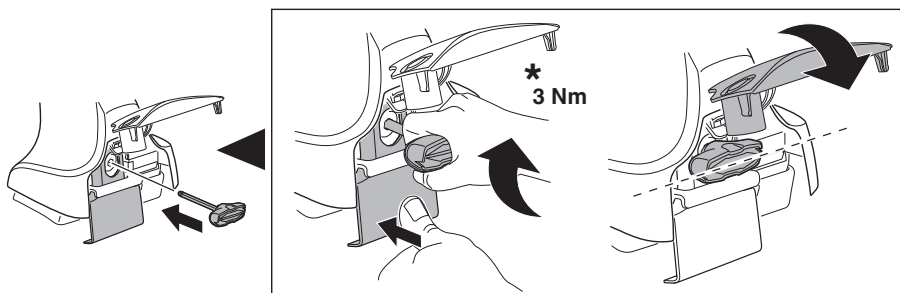

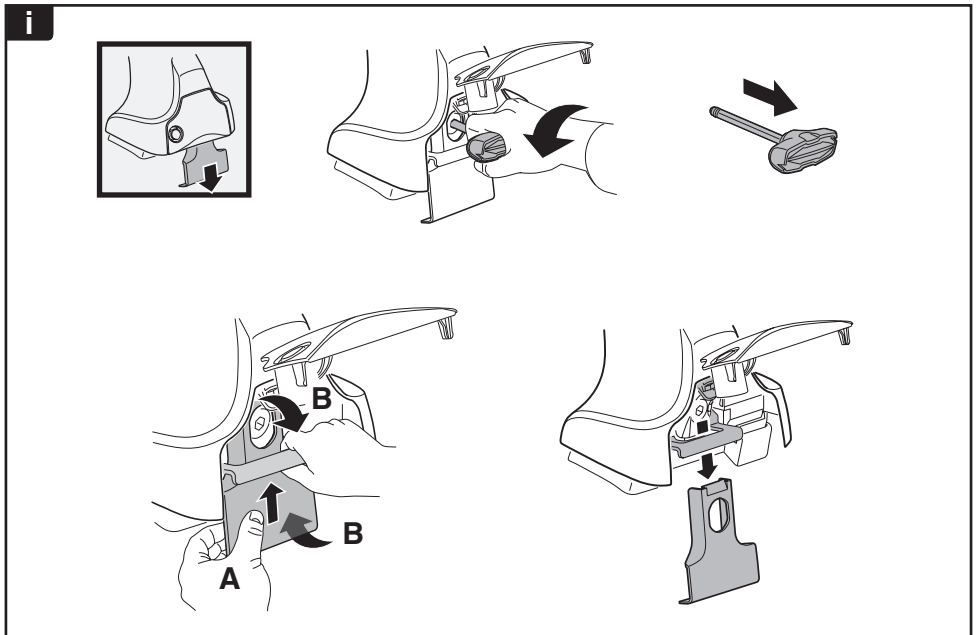
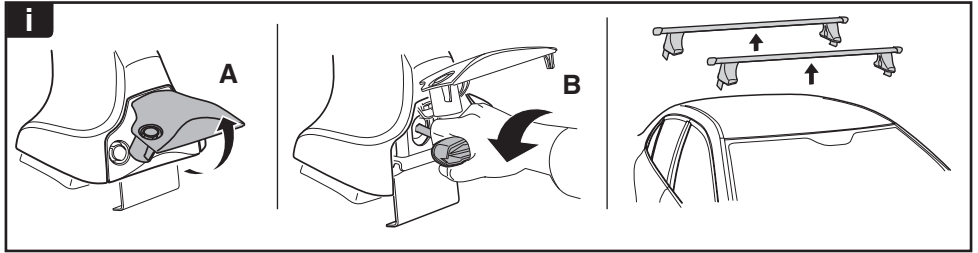
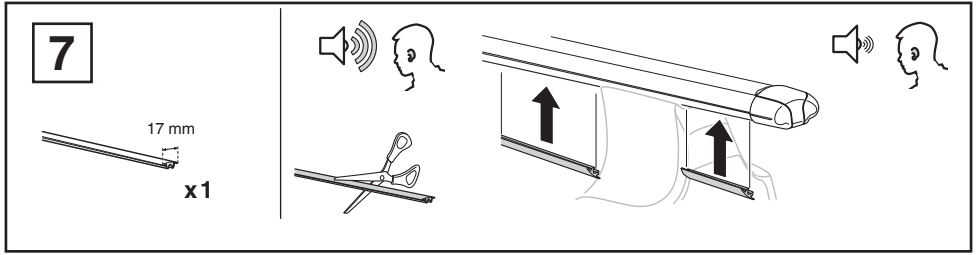



Thule Sweden AB, Box 69, 330 33 Hillerstorp, SWEDEN



info@thule.com



www.thule.com

501-7833-01