

5F.071.100

instructions

SEAT León, 5-dr Hatchback, 12-

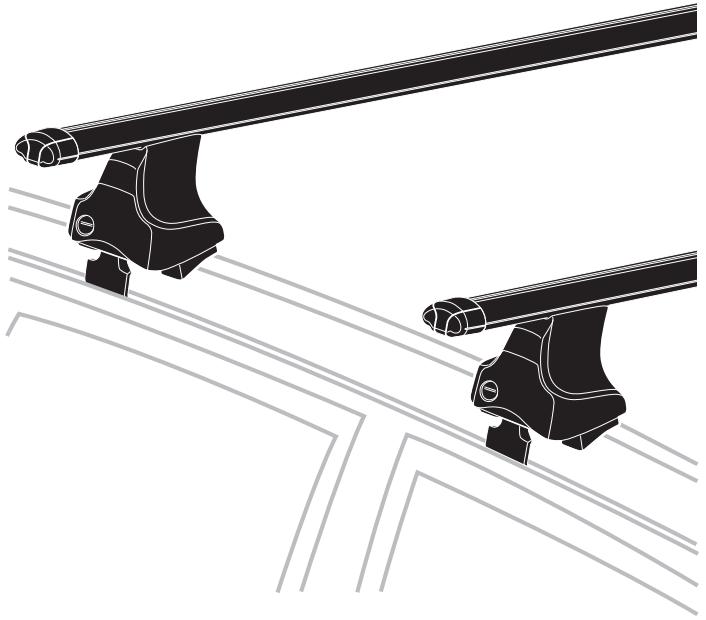

101625

ISO 11154-E

THULE[®]
SWEDEN

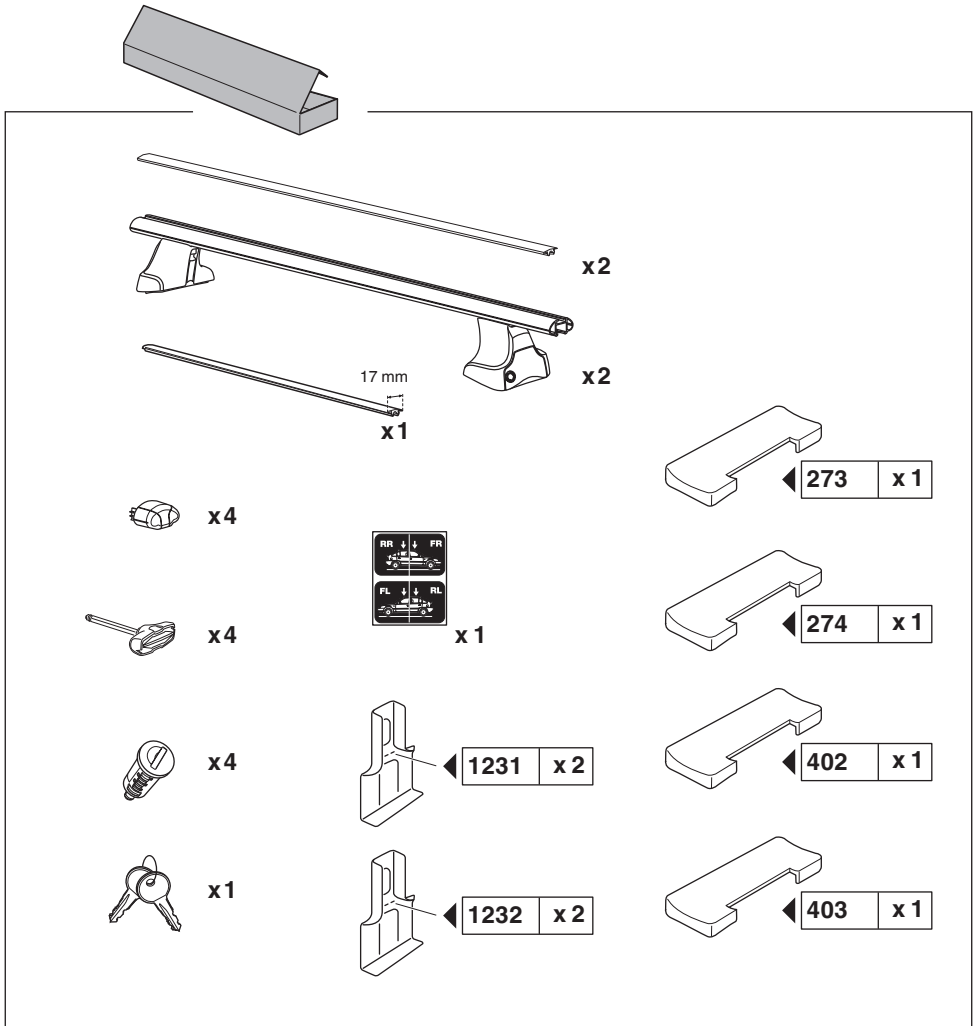
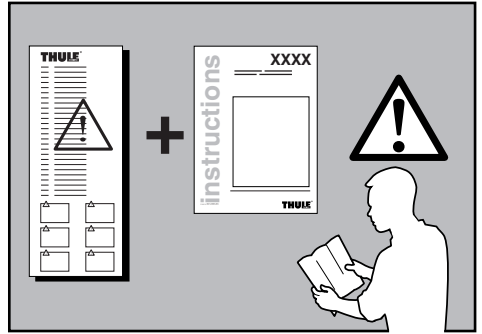
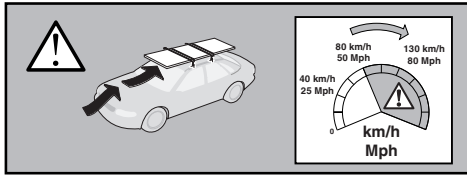
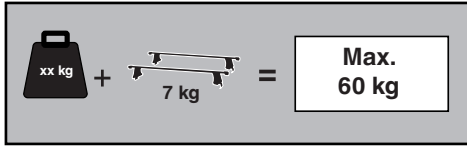

1

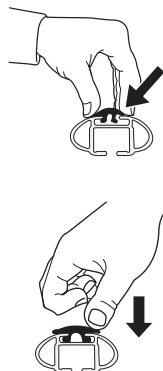
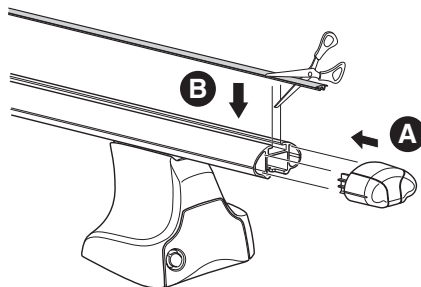
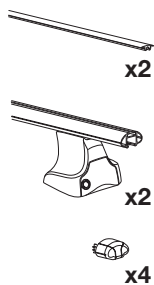

2

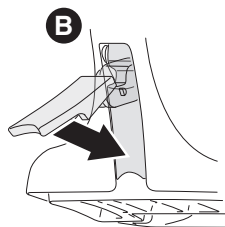
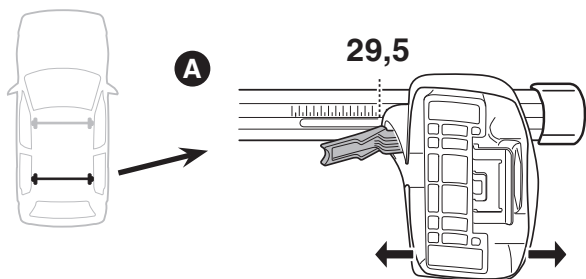
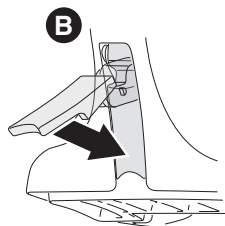
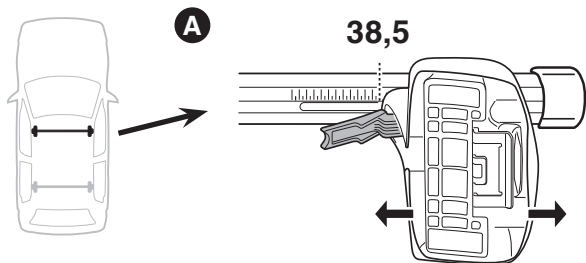
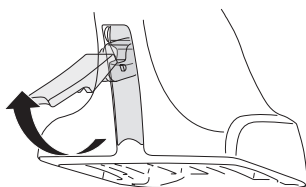

3



x4



x1

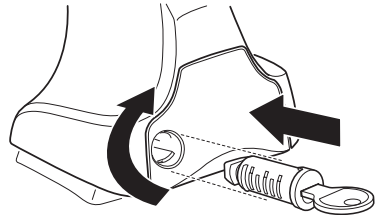
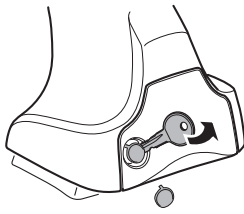

4

SEAT León, 5-dr Hatchback, 12-

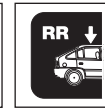
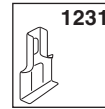
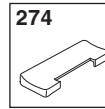
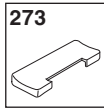
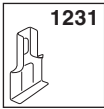
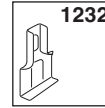
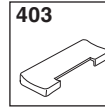
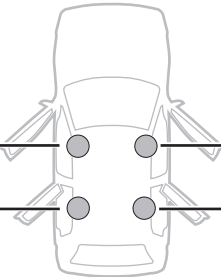
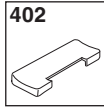
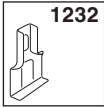

A

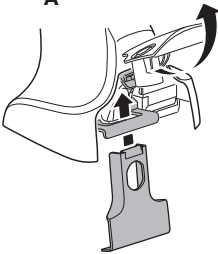

B

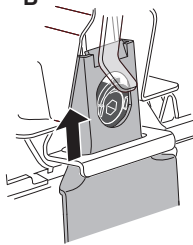

C

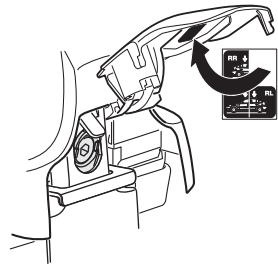
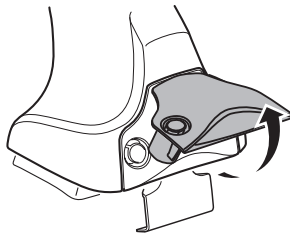
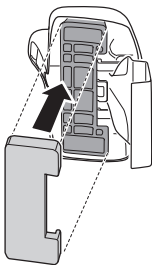
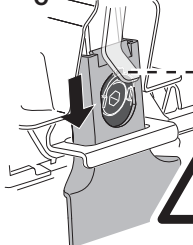

5

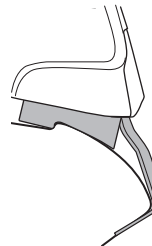
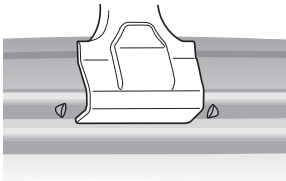
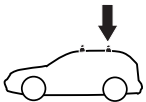
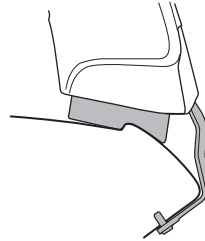
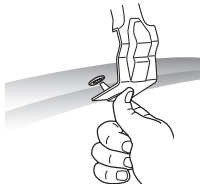
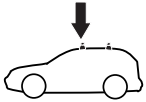
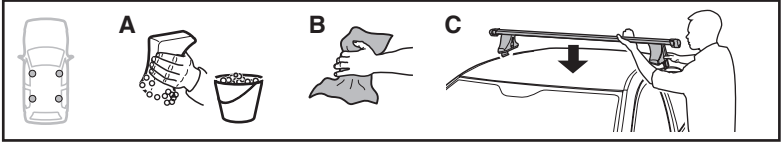

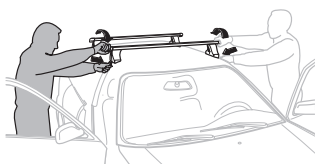
6

GB/US Tighten alternately
D Die Schrauben abwechselnd anziehen
F Serrer alternativement chaque côté
NL Afwisselend aan de linker- en de rechterkant aandraaien
I Alternare il serraggio delle viti
E Apretar alternativamente
PT Aperte alternadamente
S Dra åt växelvis
FIN Kierrä vuorotellen
EST Pinguldage vaheldumisi
LAT Pievcliet pamišus
LIT Užsukinėkite pakaitomis
PL Śruby dokręcaj naprzemiennie
RU Затягивайте попеременно

CZ Pokręta bagážnika dokręcaj dokręcaj naprzemiennie.
SK Dofahujte striedavo
SLO Privijaite izmenično.
HR Naizmjenično zategnite
HU Egymástól függetlenül szorítandó
GR Σφιγίγετε εναλλάξ
TR Dönüşümlü sıkın

中文 交替拧紧

한국어 번갈아 가며 조이십시오.

日本語 交互に締め付けてください。

ไทย ชั่งนไฟแบบสลับ

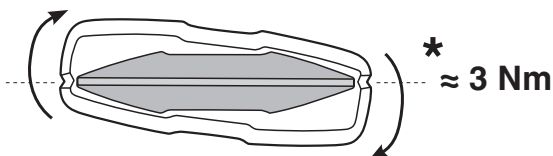
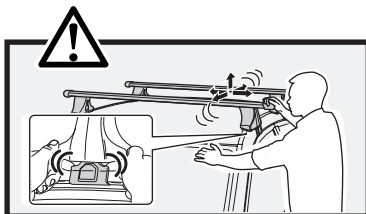
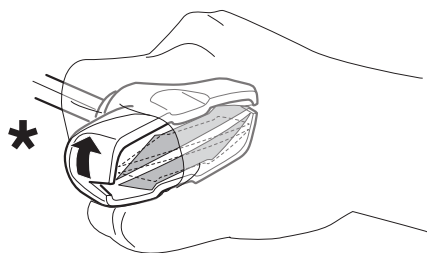
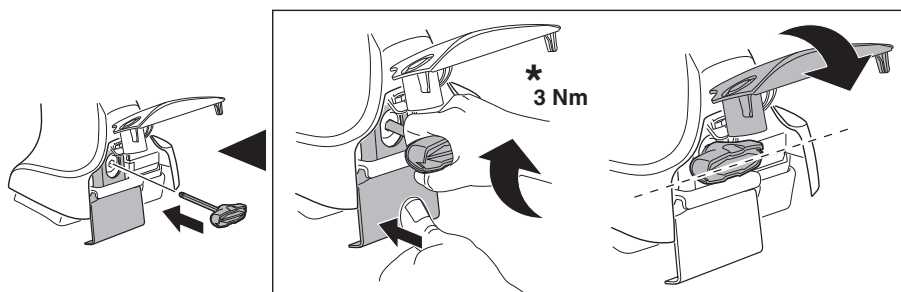

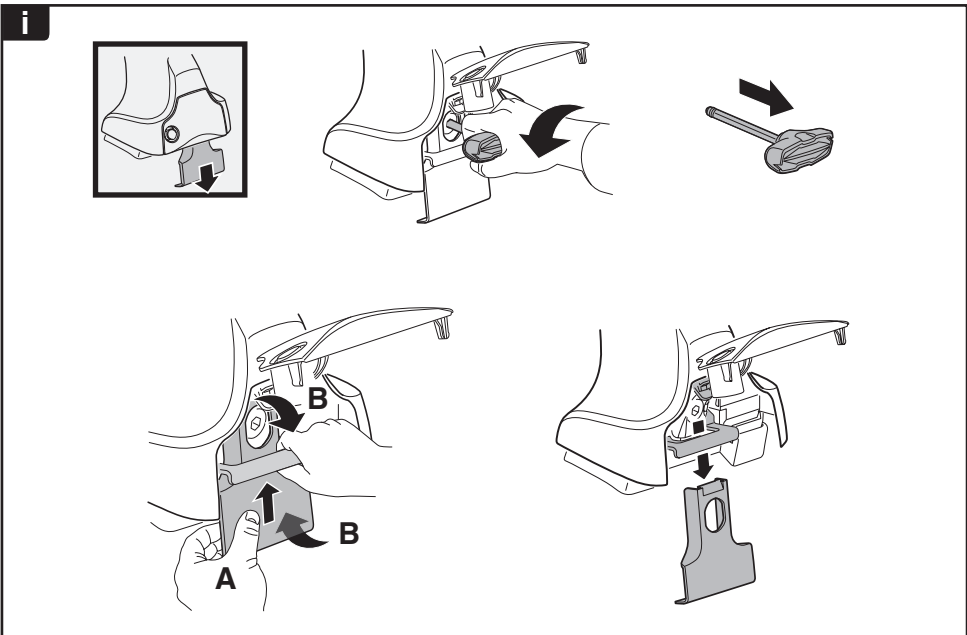
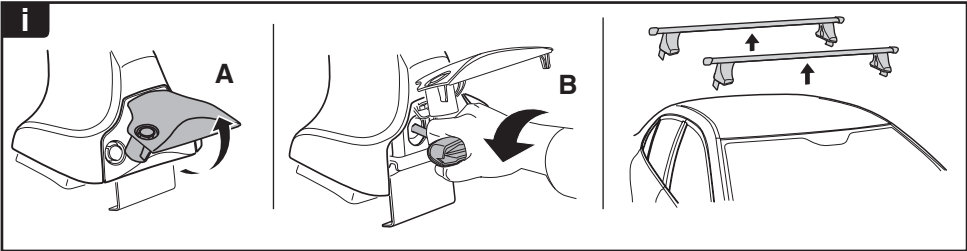
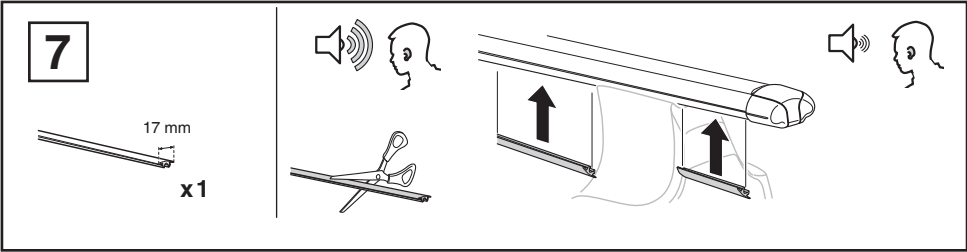



Thule Sweden AB, Box 69, 330 33 Hillerstorp, SWEDEN



info@thule.com



www.thule.com

501-7832-02